



CUSTOMER: _____ **DATE:** _____

CONTACT: _____ **PHONE:** _____ **FAX:** _____

1) APPLICATION

- INDOOR OUTDOOR MARINE ENVIRONMENT MOBILE EQUIPMENT OVERHEAD CRANE/HOISTING CRANE CHAIR
- PORTABLE EQUIPMENT FOOT PEDAL OTHER _____

2) CONTROLLER SIZE & DURABILITY

- MINIATURE: V10 H100 H7 V14 V20 S14 MEDIUM: V11 V8 D8
- SMALL: V5 VV5 S2 S21 S22 S23 S24 N6 LARGE: V3 V6 VV6 D64 DD64 K2

3) CONTROLLER FUNCTIONS

SINGLE AXIS (PICK 1 OF 3 ITEMS BELOW)

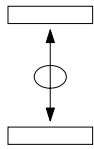

STANDARD BI-DIRECTIONAL

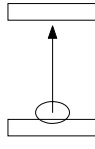

FULL TRAVEL UNI-DIRECTIONAL

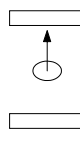

CENTER TO END UNI-DIRECTIONAL

DUAL AXIS

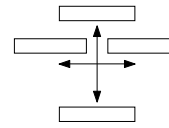

MULTI AXIS

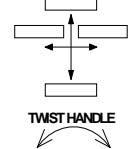

TWIST HANDLE

4) SWITCH SPECIFICATIONS

LEFT HAND MOUNTING

RIGHT HAND MOUNTING

- VOLTAGE _____ AC/DC CURRENT _____ AMPS.
 DIRECTION 1&2 DIRECTION 3&4
 NUMBER OF CONTACTS _____ NUMBER OF CONTACTS _____
 STEPLESS OR STEPS _____ STEPLESS OR STEPS _____
- SPRING RETURN SPRING RETURN
 - FRICTION BRAKE FRICTION BRAKE
 - POTENTIOMETER _____ POTENTIOMETER _____
 - ELECTRONICS ELECTRONICS

- VOLTAGE _____ AC/DC CURRENT _____ AMPS.
 DIRECTION 5&6 DIRECTION 7&8
 NUMBER OF CONTACTS _____ NUMBER OF CONTACTS _____
 STEPLESS OR STEPS _____ STEPLESS OR STEPS _____
- SPRING RETURN SPRING RETURN
 - FRICTION BRAKE FRICTION BRAKE
 - POTENTIOMETER _____ POTENTIOMETER _____
 - ELECTRONICS ELECTRONICS

5) ELECTRONICS

A) VALVE SPECIFICATIONS

VALVE MANUFACTURE _____ MODEL NUMBER _____
 SUPPLY VOLTS: _____ VDC COIL RESISTANCE: _____ OHMS THRESHOLD: _____ mA MAX. OUTPUT _____ mA
 SINGLE COIL DUAL COIL FLOW CONTROL SWITCHES FOR DIRECTIONAL VALVES PWM FREQUENCY: _____ Hz

B) SIGNAL OUTPUTS

SUPPLY VOLTS: _____ VDC 4-20mA 0-20mA 0-10V -10V to +10V OTHER _____

C) OPTIONS FOR BOTH

SINGLE MAX. (A ADJ.) DUAL MAX. (A & B ADJ.) DUAL RANGE _____ mA RAMP TIME _____ SEC.

6) HANDLE TYPE

- STANDARD KNOB MECHANICAL INTERLOCK PUSHBUTTON DEADMAN PUSH DEADMAN PULL DEADMAN
- PALM HANDLE _____

7) NAMEPLATE SPECIFICATIONS

- STANDARD NAMEPLATE _____ SPECIAL NAMEPLATE (ATTACH LAYOUT DRAWING OR SPECIFICATIONS)

8) ENCLOSURE

- GENERAL PURPOSE WEATHERPROOF CORROSIVE RESISTANT (PLASTIC) PORTABLE CONSOLES
- ENCLOSURE DIMENSIONS L= _____ W= _____ H= _____ TS1 TS2

9) NOTES

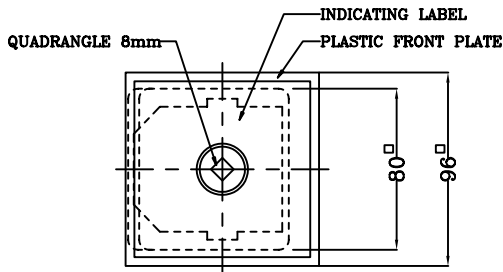
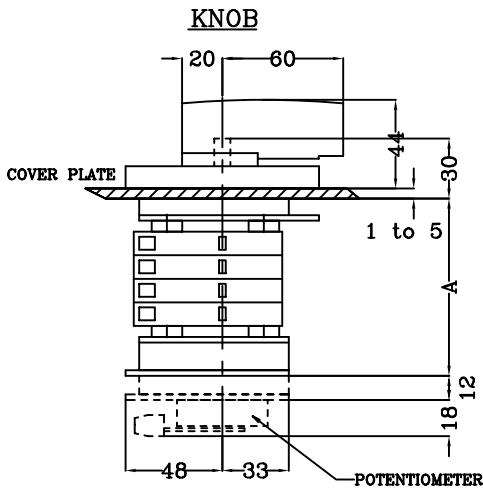
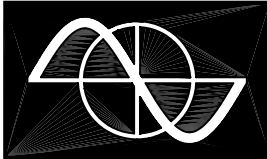

BALL HANDLE

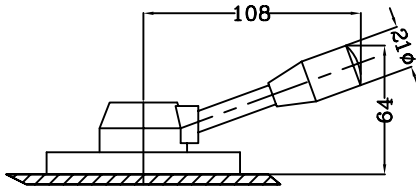

ROTARY MECHANISM

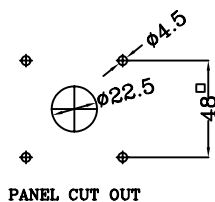
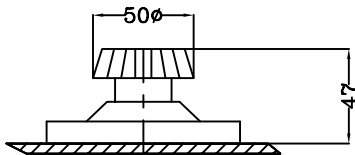

THE N6 MASTER SWITCH IS RUGGED AND IS BUILT FOR LONG LIFE. THE MODULAR DESIGN ENABLES THE SWITCHING DEVICE TO BE USED UNIVERSALLY. IT IS BUILT FOR 10 MILLION OPERATIONS. IT IS OIL, OZONE, UV AND SALT ATMOSPHERE (OCEAN CONDITION) RESISTANT. CONTACTS RATED AT 2A 250V AC15 RES. 1A 24V DC13 (GREY STANDARD) OR 4A 250V AC15 (YELLOW SPECIAL)

S800a DC CONTACTS (NOT CSA)
25A 24VDC, 25A 80VDC, 18A 110VDC, 1A 220VDC
DEGREE OF PROTECTION FRONT: IP54
N6 SWITCHES ARE IEC 9475-1, VDE 0660-200, CSA APPROVED.
FILE# 154946

STANDARD CONTACTS

SIZE	# OF CONTACTS	A DIMENSION	RETURN SPRING
01	2	51	+25
02	4	63	
03	6	76	
04	8	88	
05	10	101	
06	12	113	

S800 DC CONTACTS

SIZE	# OF CONTACTS	A DIMENSION	RETURN SPRING
01	2	45	+25
02	4	60	
03	6	75	
04	8	90	
05	10	105	
06	12	120	

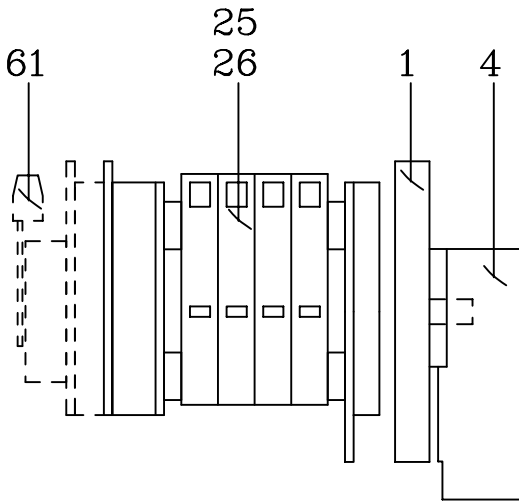
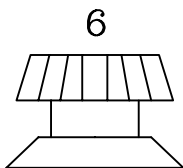
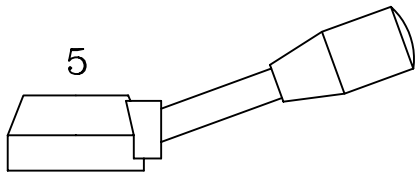
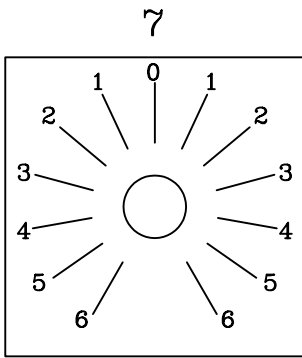
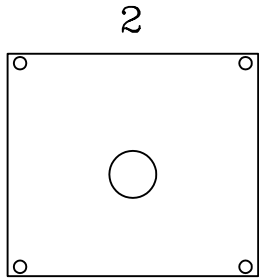
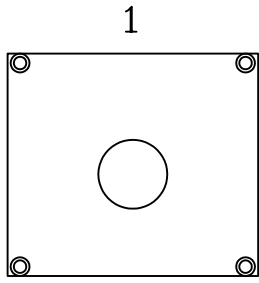
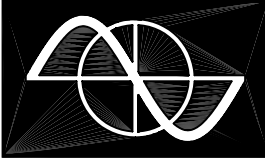

62 & 75

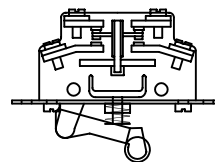
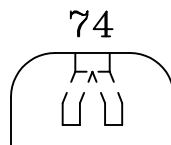
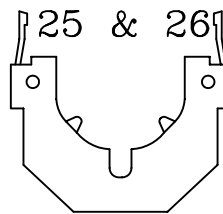
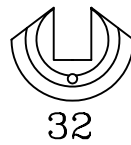
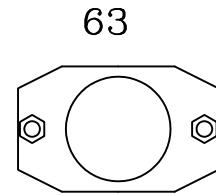
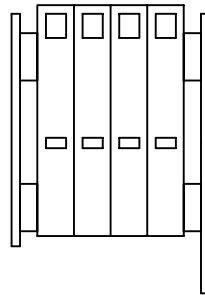

73

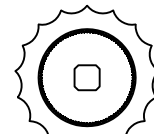
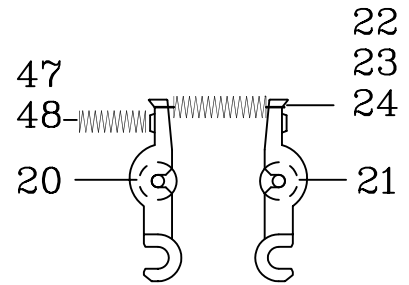

16-18
FOR 2 RATCHET ARMS
40-42
FOR 1 RATCHET ARM

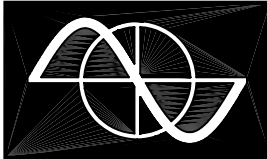

<u>PART#</u>	<u>DESCRIPTION</u>
1	MOUNTING PLATE
2	GASKET
4	KNOB
5	BALL HANDLE
6	ROTARY MECHANISM (46mm)
6.1	ROTARY MECHANISM (76mm)
7	PLASTIC FRONT PLATE WITH INDICATING LABEL
16	0 STEP RATCHET (SMOOTH) FOR TWO RATCHET ARMS
17	4 STEP RATCHET FOR TWO RATCHET ARMS
18	6 STEP RATCHET FOR TWO RATCHET ARMS
20	RATCHET ARM
21	RATCHET ARM ROLLER BEARING
22	RATCHET ARM SPRING WEAK FOR TWO RATCHET ARMS
23	RATCHET ARM SPRING NORMAL FOR TWO RATCHET ARMS
24	RATCHET ARM SPRING STRONG FOR TWO RATCHET ARMS
25	CONTACT SET 6A 250V AC GRAY
26	CONTACT SET 16A 250V AC YELLOW
32	BLANK PLASTIC CAM
40	0 STEP RATCHET (SMOOTH) FOR ONE RATCHET ARM
41	4 STEP RATCHET FOR ONE RATCHET ARM
42	6 STEP RATCHET FOR ONE RATCHET ARM
47	RATCHET ARM SPRING NORMAL FOR ONE RATCHET ARM
48	RATCHET ARM SPRING STRONG FOR ONE RATCHET ARM
61	POTENTIOMETER SEE SECTION 6
62	SWITCH CONTACT ASSEMBLY AC
63	FRICITION BRAKE ASSEMBLY
73	DC CONTACT S800a
74	BLOW OUT CAP
75	SWITCH CONTACT ASSEMBLY DC