



CUSTOMER: _____ **DATE:** _____

CONTACT: _____ **PHONE:** _____ **FAX:** _____

1) APPLICATION

- INDOOR OUTDOOR MARINE ENVIRONMENT MOBILE EQUIPMENT OVERHEAD CRANE/HOISTING CRANE CHAIR
- PORTABLE EQUIPMENT FOOT PEDAL OTHER _____

2) CONTROLLER SIZE & DURABILITY

- MINIATURE: V10 H100 H7 V14 V20 S14 MEDIUM: V11 V8 D8
- SMALL: V5 VV5 S2 S21 S22 S23 S24 N6 LARGE: V3 V6 VV6 D64 DD64 K2

3) CONTROLLER FUNCTIONS

SINGLE AXIS (PICK 1 OF 3 ITEMS BELOW)

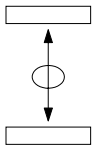

STANDARD BI-DIRECTIONAL

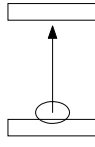

FULL TRAVEL UNI-DIRECTIONAL

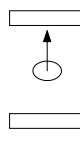

CENTER TO END UNI-DIRECTIONAL

DUAL AXIS

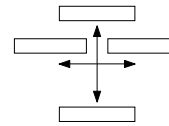

MULTI AXIS

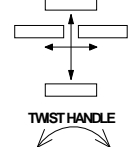

TWIST HANDLE

4) SWITCH SPECIFICATIONS

LEFT HAND MOUNTING

- VOLTAGE _____ AC/DC CURRENT _____ AMPS.
 DIRECTION 1&2 DIRECTION 3&4
 NUMBER OF CONTACTS _____ NUMBER OF CONTACTS _____
 STEPLESS OR STEPS _____ STEPLESS OR STEPS _____
- SPRING RETURN SPRING RETURN
 - FRICTION BRAKE FRICTION BRAKE
 - POTENTIOMETER _____ POTENTIOMETER _____
 - ELECTRONICS ELECTRONICS

RIGHT HAND MOUNTING

- VOLTAGE _____ AC/DC CURRENT _____ AMPS.
 DIRECTION 5&6 DIRECTION 7&8
 NUMBER OF CONTACTS _____ NUMBER OF CONTACTS _____
 STEPLESS OR STEPS _____ STEPLESS OR STEPS _____
- SPRING RETURN SPRING RETURN
 - FRICTION BRAKE FRICTION BRAKE
 - POTENTIOMETER _____ POTENTIOMETER _____
 - ELECTRONICS ELECTRONICS

5) ELECTRONICS

A) VALVE SPECIFICATIONS

VALVE MANUFACTURE _____ MODEL NUMBER _____

SUPPLY VOLTS: _____ VDC COIL RESISTANCE: _____ OHMS THRESHOLD: _____ mA MAX. OUTPUT _____ mA

SINGLE COIL DUAL COIL FLOW CONTROL SWITCHES FOR DIRECTIONAL VALVES PWM FREQUENCY: _____ Hz

B) SIGNAL OUTPUTS

SUPPLY VOLTS: _____ VDC 4-20mA 0-20mA 0-10V -10V to +10V OTHER _____

C) OPTIONS FOR BOTH

SINGLE MAX. (A ADJ.) DUAL MAX. (A & B ADJ.) DUAL RANGE _____ mA RAMP TIME _____ SEC.

6) HANDLE TYPE

- STANDARD KNOB MECHANICAL INTERLOCK PUSHBUTTON DEADMAN PUSH DEADMAN PULL DEADMAN
- PALM HANDLE _____

7) NAMEPLATE SPECIFICATIONS

STANDARD NAMEPLATE _____ SPECIAL NAMEPLATE (ATTACH LAYOUT DRAWING OR SPECIFICATIONS)

8) ENCLOSURE

- GENERAL PURPOSE WEATHERPROOF CORROSIVE RESISTANT (PLASTIC) PORTABLE CONSOLES
- ENCLOSURE DIMENSIONS L= _____ W= _____ H= _____ TS1 TS2

9) NOTES

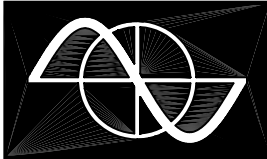

THE FOOT PEDAL IS RUGGED, COMPACT AND IT'S MODULAR DESIGN IS SUITABLE FOR ELECTRO-HYDRAULIC APPLICATIONS.

THE P10 IS SUPPLIED AS A STEPLESS SETPOINT DEVICE WITH ONE POTENTIOMETER AND UP TO 3 CONTROL CONTACTS.

THE P11 IS SUPPLIED WITH 1-0-1 CONTROL WITH DETENT.

IT IS BUILT FOR 8 MILLION OPERATIONS.

IT IS OIL, OZONE, UV AND SALT ATMOSPHERE (OCEAN CONDITION) RESISTANT.

CONTACTS ARE RATED AT 0.5A 110V AC 15 RES. 1.5A 24V DC 13 DEGREE OF PROTECTION IP54

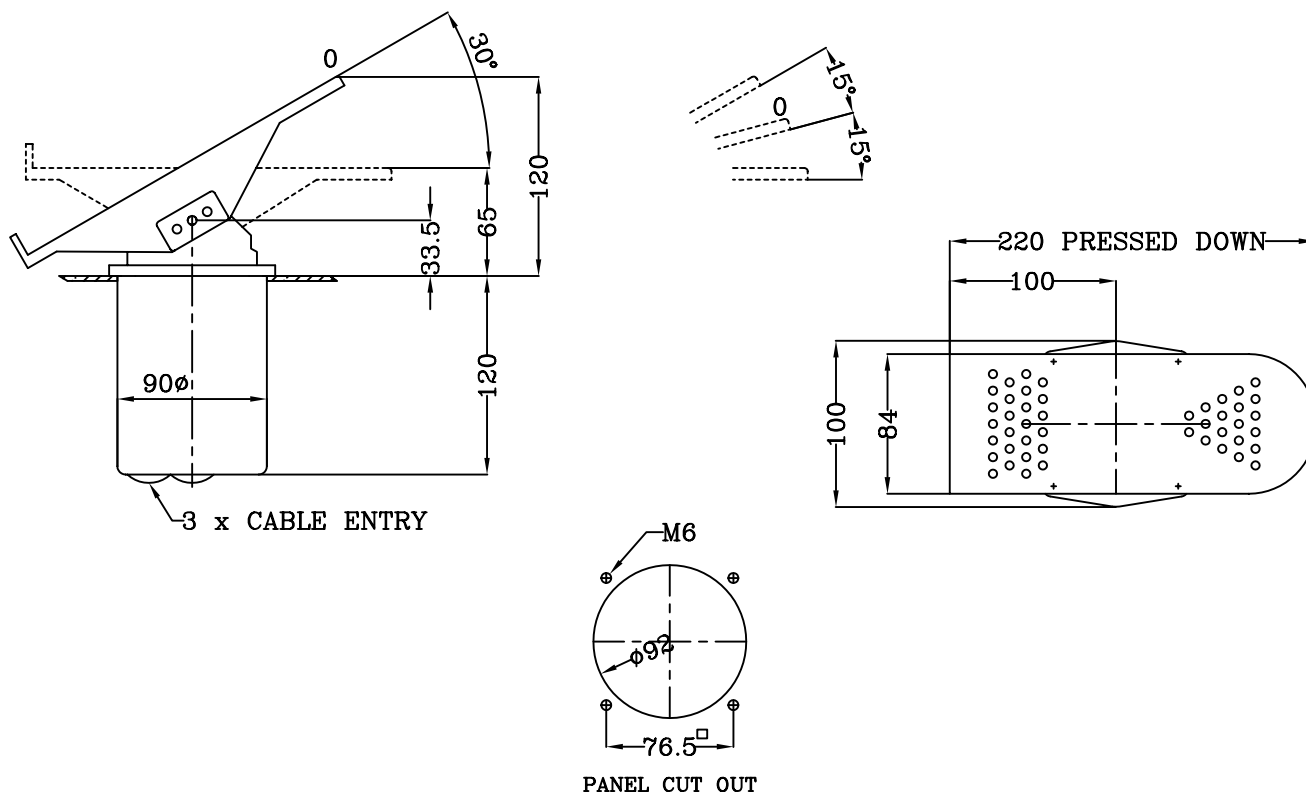

P7-STANDARD FOOT PEDAL
PP7-STANDARD FOOT PEDAL
P8-STANDARD FOOT PEDAL C/W SHROUD
PP8-STANDARD FOOT PEDAL C/W SHROUD
CONTACT ARRANGEMENT
A-Z-FROM SHEET 20.2.1
O-SPECIAL CONTACT ARRANGEMENT
X-IF NOT REQUIRED
z-SPRING RETURN
r-BRAKE
P-POTENTIOMETER SEE SECT. 6
p-POTENTIOMETER MTG. ONLY
X-IF NOT REQUIRED

P10-STANDARD FOOT PEDAL
P11-CENTER POS. 1-0-1
P12-STANDARD FOOT PEDAL
CONTACT ARRANGEMENT
A-Z-FROM SHEET 20.2.1
O-SPECIAL CONTACT ARRANGEMENT
X-IF NOT REQUIRED
z-SPRING RETURN
r-BRAKE
P-POTENTIOMETER SEE SECT. 6
p-POTENTIOMETER MTG. ONLY
X-IF NOT REQUIRED
G-ENCLOSURE
X-IF NOT REQUIRED

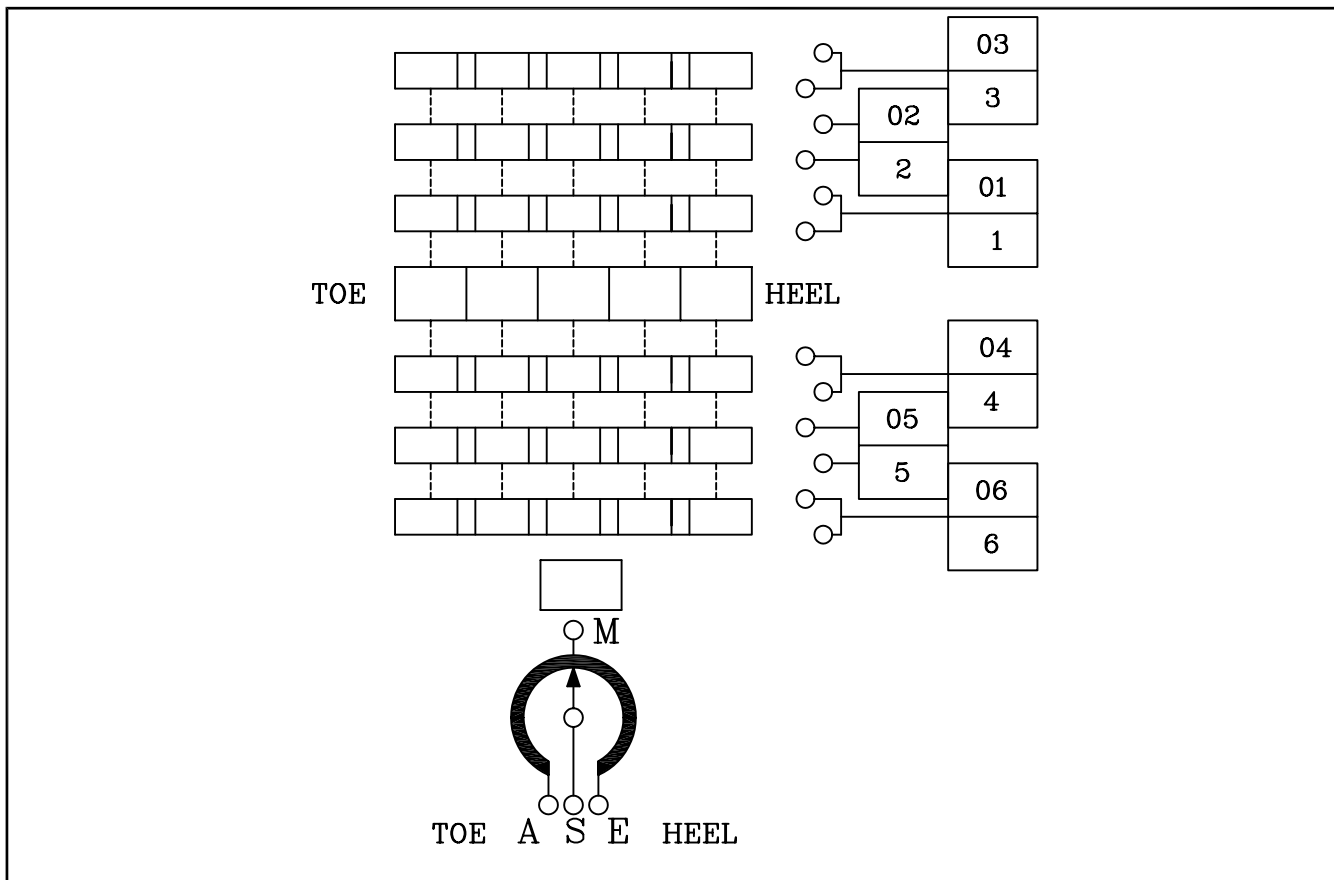

GESSMANN FOOT PEDAL		JOB #
DATE:	FROM:	
NAME:		